



XIPWATERTECH
Is a pippohydro brand



APPLICAZIONI

Elettropompe centrifughe, monoblocco e monogirante con corpo pompa, collegato al motore mediante supporto. Con bocche di aspirazione e di mandata flangiante (PN 10) e controflange del tipo filettato. Queste macchine sono adatte per il pompaggio di acqua pulita e di altri liquidi chimicamente e meccanicamente non aggressivi; la possibilità di installazione in qualunque posizione, fatta eccezione di quella che comporta la bocca aspirante rivolta verso l'alto. Adatta per le più svariate esigenze in campo civile, agricolo, industriale o impiantistico in generale. Approvvigionamenti d'acqua, irrigazioni a pioggia o a scorrimento, alimentazioni autoclavi e sopraelevazioni di pressione, riscaldamento e condizionamento, qualsiasi altro impiego che comporta il travaso di liquidi puliti in genere.

APPLICATION

Centrifugal, monoblock and single-impeller electrical pumps with pump body, with connection to the motor by means of a support unit. With flanged inlet and delivery openings (PN 10) and threaded counter-flanges. These machines are ideal for pumping clean water and other chemically and mechanically non-aggressive liquids. They are adapt for civil, agricultural, industrial or general plant uses. Water supply, spray or flowing irrigation, autoclave feed, high pressure system, heating, conditioning and any other general service requiring transfer of clean liquids.

LIMITI D'IMPIEGO

- Temperatura liquido fino a 35°C (per un uso domestico secondo EN 60335-2-41)
- Temperatura max. liquido: 90°C (per altri impieghi)
- Temperatura ambiente fino a 40°C
- Altezza d'aspirazione manometrica fino a 7 mt.
- Servizio continuo
- Indice di efficienza minimo (BEP) MEI ≥ 0,4

MOTORE

- Monofase 230V-50Hz
- Trifase 230/400V-50Hz P2 ≤ 7,5 kW
- Trifase 400/690V-50Hz P2 > 7,5 kW
- Motore elettrico ad induzione a 2 poli (n = 2850 min⁻¹)
- Isolamento Classe F
- Protezione IP 55

MATERIALI

- Corpo pompa Ghisa
- Supporto motore Ghisa
- Girante Ghisa
- Albero motore Acciaio Inox AISI 304
- Tenute meccaniche Ceramica/Grafite/NBR

OPERATING CONDITIONS

- Liquid temperature up to 35°C (for home use according to EN 60335-2-41)
- Max. liquid temperature: 90°C (for other uses)
- Ambient temperature up to 40°C
- Total suction lift up to 7 mt.
- Continuous duty
- Minimum efficiency index (BEP) MEI ≥ 0,4

MOTOR

- Single-phase 230V-50Hz
- Three-phase 230/400V-50Hz P2 ≤ 7,5 kW
- Three-phase 400/690V-50Hz P2 > 7,5 kW
- Two-Pole induction motor (n = 2850 min⁻¹)
- Insulation Class F
- Protection IP 55

MATERIALS

- Pump body Cast Iron
- Motor Support Cast Iron
- Impeller Cast Iron
- Shaft with rotor Stainless Steel AISI 304
- Mechanical seal Ceramic/Graphite/NBR

TIPO TYPE		POTENZA NOMINALE NOMINAL POWER		POTENZA ASSORBITA INPUT POWER	AMPERE		Q = PORTATA - CAPACITY												
Monofase Single-phase	Trifase Three-phase	P2		P1	Monofase Single-phase	Trifase Three-phase	m ³ /h	6	7,5	9	12	15	18	21	24	27	30	33	36
		HP	KW	KW			lit/1'	100	125	150	200	250	300	350	400	450	500	550	600
M 32-160 C	32-160 C	2	1,5	2,7	12	4,8	Prevalenza manometrica totale in m.C.A. - Total head in meters w.c.												
M 32-160 B	32-160 B	3	2,2	3,3	15	5	25,5	25,3	25	24	23	21,5	20	18	15,5				
	32-160 A	4	3	4,3		7	28,8	28,5	28	27	26	24,5	23	21,5	18,5	15,5			
							36,5	36	35,5	34,5	33	31,5	30	28,5	26	23,5			
M 32-200 C	32-200 C	5,5	4	5,7	27	8,8	40,7	40,5	40	39,5	39	38	36,5	35	33	31,5	29	26	
	32-200 B	7,5	5,5	8,6		14	55,7	55,5	55	54,5	54	53	51,5	50	48	46,5	44,5	42,5	
	32-200 A	10	7,5	9,5		15	60,7	60,5	60	59,5	58,5	57	55,5	54	52	49,5	47,5	45	
	32-250 C	12,5	9,2	12		19		70	69,5	68,5	67,5	66	64,5	62,5	59,5	56	51	46	
	32-250 B	15	11	13,5		21,5		81	80,5	79,5	78,5	77	75,5	73,5	71	67,5	63,5	58	
	32-250 A	20	15	15,5		25		90,5	90	89,5	89	87,5	86	84	81,5	78	74	68,5	

TIPO TYPE		POTENZA NOMINALE NOMINAL POWER		POTENZA ASSORBITA INPUT POWER	AMPERE		Q = PORTATA - CAPACITY																
Monofase Single-phase	Trifase Three-phase	P2		P1	Monofase Single-phase	Trifase Three-phase	m³/h	9	12	15	18	21	24	27	30	33	36	39	42	48	54		
		HP	kW	kW			lt/1'	150	200	250	300	350	400	450	500	550	600	650	700	800	900		
Prevalenza manometrica totale in m.C.A. - Total head in meters w.c.																							
M 40-160 B	40-160 30	4	3	4,8	22	7,5	H (m)	32,7	32,5	32,3	32	31,5	30,5	29,5	28	27	25,5	23	21				
M 40-160 A	40-160 40	5,5	4	5,7	28	8,8		36,2	36	35,8	35,5	35	34	33	32	31	29,5	28	26	22			
	40-200 55	7,5	5,5	8,6		14		46,5	46	45,5	45	44,5	43,5	42,5	41,5	40,5	39,5	38,5	37	34,5	31,5		
	40-200 75	10	7,5	11,3		17,5		56	55,5	55	54,5	54	53	52	51	50	49	48	46,5	44	40,5		
	40-250 110	15	11	15,5		24,5		74	73,9	73,8	73,7	73,5	73	72	71	70	68,5	67	65,5	61,5	54		
	40-250 150	20	15	20		32		91,5	91,4	91,3	91,2	91	90,5	90	89	88	87	85,5	83,5	79,5	73		

TIPO TYPE		POTENZA NOMINALE NOMINAL POWER		POTENZA ASSORBITA INPUT POWER	AMPERE		Q = PORTATA - CAPACITY																
Monofase Single-phase	Trifase Three-phase	P2		P1	Monofase Single-phase	Trifase Three-phase	m³/h	21	24	27	30	33	36	39	42	48	54	60	66	72	78		
		HP	kW	kW			lt/1'	350	400	450	500	550	600	650	700	800	900	1000	1100	1200	1300		
Prevalenza manometrica totale in m.C.A. - Total head in meters w.c.																							
M 50-160 D	50-160 D	4	3	4,8	22	7,5	H (m)	25	24,5	24	23,5	22,8	22	21,3	20,5	19	17	15	13	10			
M 50-160 C	50-160 C	5,5	4	5,7	27	8,8		29,5	29,2	28,8	28,3	27,8	27,1	26,4	25,6	24	22,5	20,5	18	15,5			
	50-160 B	7,5	5,5	8,2		13,2		37	36,8	36,5	36	35,5	35	34,5	34	32	30,5	28,5	26	23,5	20,5		
	50-160 A	10	7,5	9,5		15		40	39,8	39,5	39	38,5	38	37,5	37	35	33,5	31,5	29	26,5	23		
	50-200 C	12,5	9,2	12		19			48,7	48,5	48,2	47,8	47,5	47	46,5	45	43,5	42	39,5	37	33		
	50-200 B	15	11	13,5		21,5			52,7	52,5	52,2	51,7	51,2	50,7	50,2	49,2	48	46	43,5	41	38		
	50-200 A	20	15	18		29			64,5	64	63,5	63	62,5	62	61,5	60,5	59,5	58	56,5	54,5	51,5		
	50-250 C	20	15	20		32				71,3	71	70,5	70	69,5	68,5	67	65	63	61	58	54		
	50-250 B	25	18,5	23		36,5				80,8	80,5	80	79,5	79	78,5	77	75	73	70,5	68	65		
	50-250 A	30	22,5	27		43				90	89,7	89,3	89	88,5	88	86,5	85	83	81	79	71		

TIPO TYPE		POTENZA NOMINALE NOMINAL POWER		POTENZA ASSORBITA INPUT POWER	AMPERE		Q = PORTATA - CAPACITY																
Trifase Three-phase	P2		P1	Trifase Three-phase	m³/h	42	48	54	60	66	72	78	84	96	108	120	132	144	156				
	HP	kW	kW		lt/1'	700	800	900	1000	1100	1200	1300	1400	1600	1800	2000	2200	2400	2600				
Prevalenza manometrica totale in m.C.A. - Total head in meters w.c.																							
65-160 E	7,5	5,5	8	13	H (m)	24,5	24,2	24	23,5	23	22,5	21,5	20,5	18,5	16	12,5							
65-160 D	10	7,5	10	16		28,5	28,2	28	27,5	27	26,5	25,8	25	23	21	18	14						
65-160 C	12,5	9,2	11,5	18,5		32	31,7	31,5	31,2	30,7	30,2	29,7	29	27	25	22	19	16					
65-160 B	15	11	13,5	21,5		35,5	35	34,8	34,5	34	33,5	33	32,5	31	29	26,5	24	20					
65-160 A	20	15	16	26		40	39,5	39	38,5	38	37,5	37	36,5	35,5	33,5	31	28,5	26					
65-200 C	20	15	20	32			48,5	48	47,5	47	46,2	45,5	44,5	42,5	40,5	38	34,5	31					
65-200 B	25	18,5	23	36,5			52,5	52	51,5	51	50,5	50	49	47	45	43	40	36					
65-200 A	30	22,5	27	43			60,5	60	59,5	59	58,5	58	57,5	56	54,5	52,5	49,5	45,5					
65-250 B	40	30	37	58			79	78,5	78	77	76	75	74	72	69	66	63	58					
65-250 A	50	37	46	72			89,5	89	88,5	87,5	86,5	85,5	84	82,5	80	77	74	70	66				

TIPO TYPE		POTENZA NOMINALE NOMINAL POWER		POTENZA ASSORBITA INPUT POWER	AMPERE		Q = PORTATA - CAPACITY																
Trifase Three-phase	P2		P1	Trifase Three-phase	m³/h	66	72	78	84	96	108	120	132	144	156	168	180	195	210	225	240		
	HP	kW	kW		lt/1'	1100	1200	1300	1400	1600	1800	2000	2200	2400	2600	2800	3000	3250	3500	3750	4000		
Prevalenza manometrica totale in m.C.A. - Total head in meters w.c.																							
80-160 D	15	11	12,5	20,5	H (m)	27,5	27,4	27,3	27,1	26,4	25,2	24	22,5	21	19,2	17,4	15,5						
80-160 C	20	15	15	24		30,6	30,5	30,4	30,2	29,6	28,7	27,5	26,2	24,8	23,2	21,5	19,6	17					
80-160 B	25	18,5	18,5	30		35	34,9	34,8	34,6	34,1	33,4	32,5	31,3	30,2	28,7	27	25,3	22,8	20				
80-160 A	30	22,5	22	35		38,6	38,5	38,2	38	37,7	37	36,3	35,3	34,2	33	31,6	30	27,8	25	22			
80-200 B	40	30	33,5	54		54,1	54	53,8	53,6	53,1	52,2	51,3	50,4	49,2	47,7	46,2	44,2	41,2	38	33,6	28,5		
80-200 A	50	37	39	62		58,8	58,7	58,5	58,3	57,8	57,2	56,3	55,4	54,2	53	51,5	50	48	45	42	39		

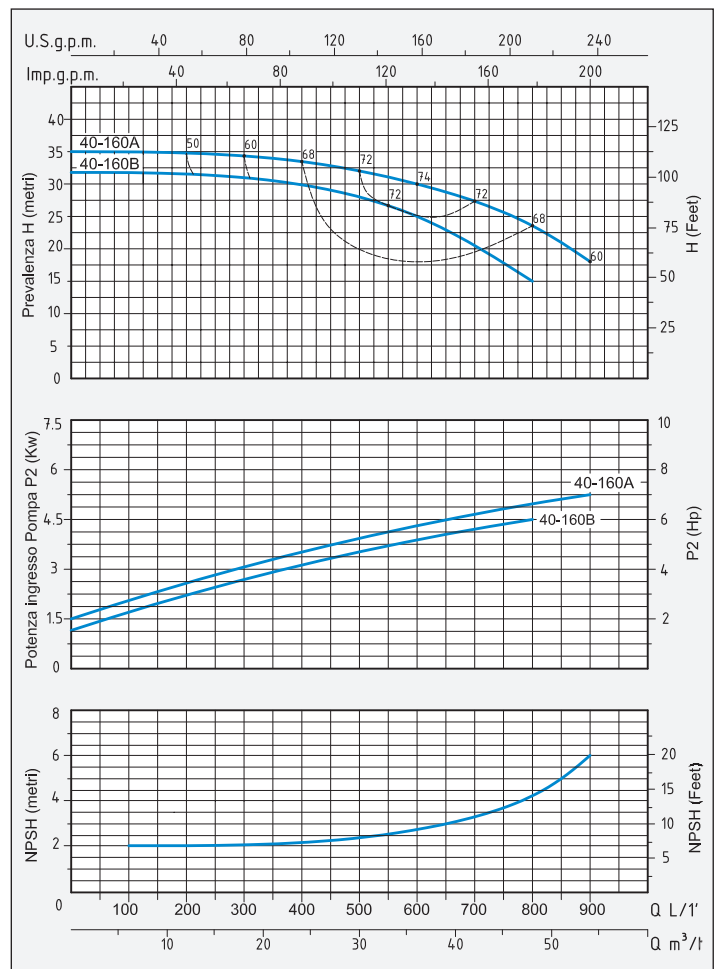
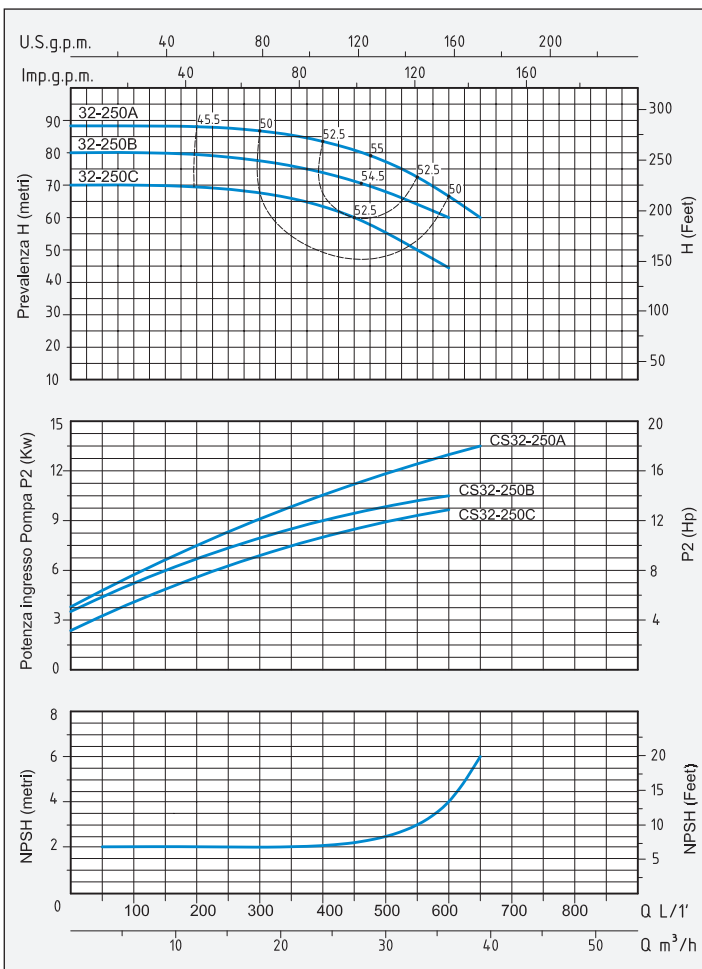
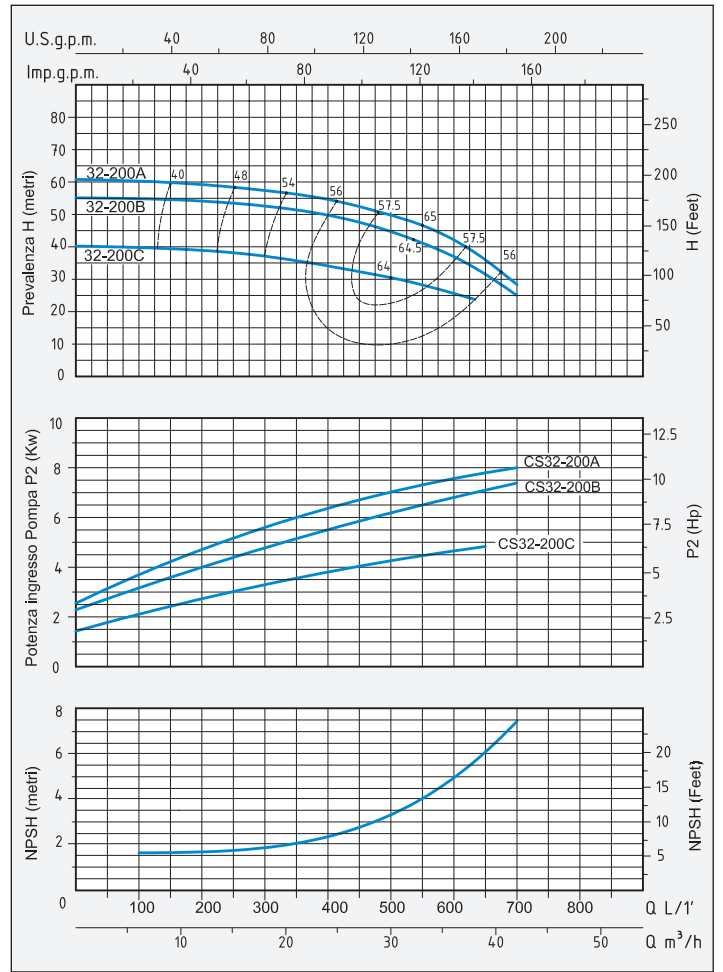
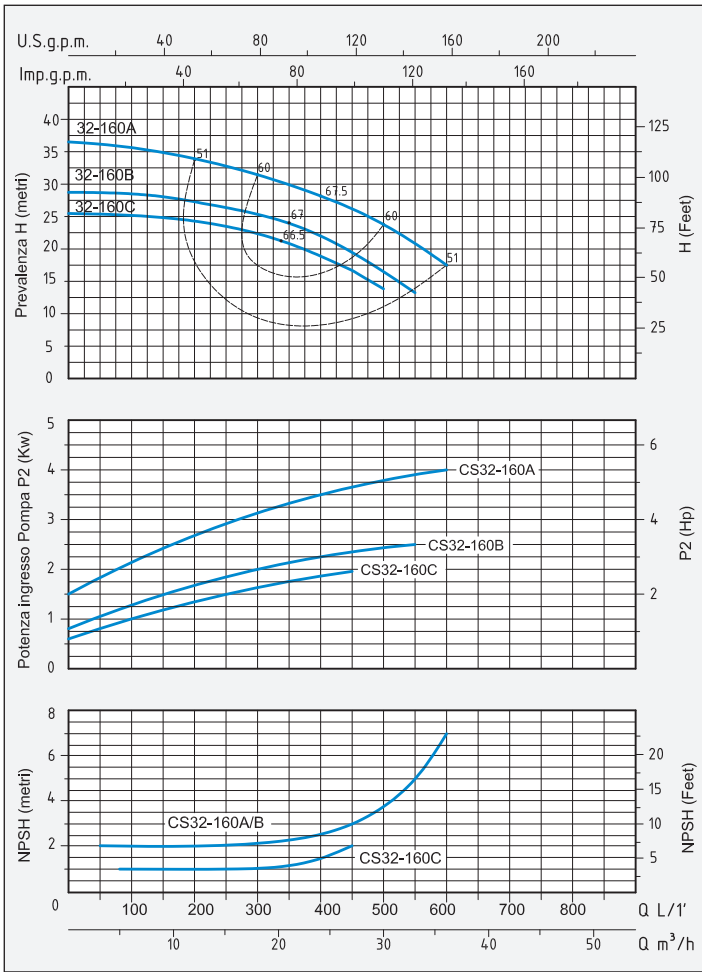

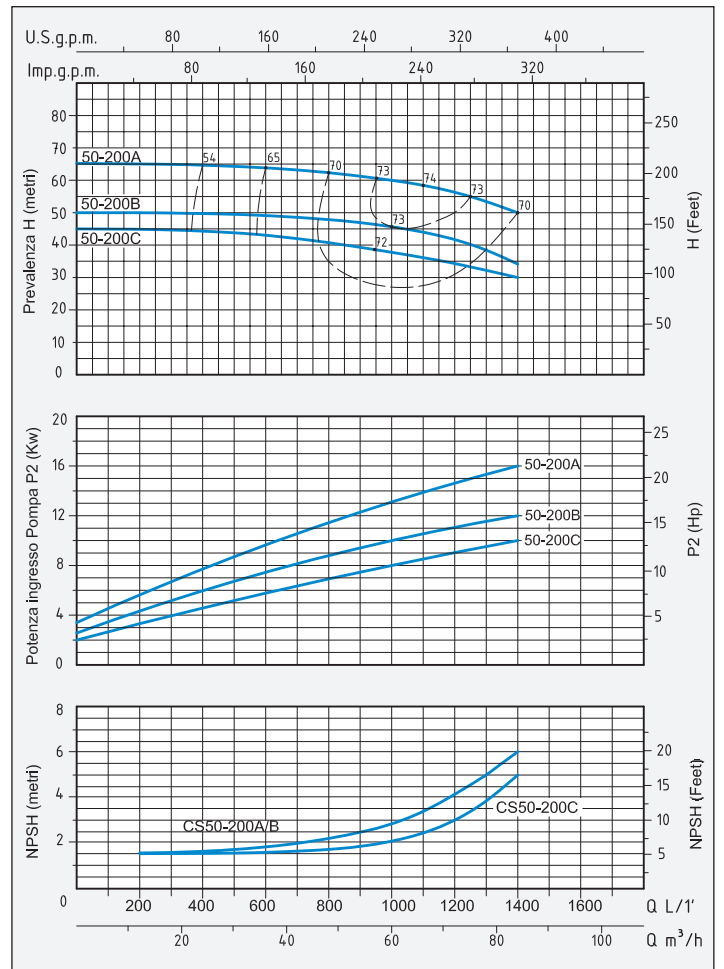
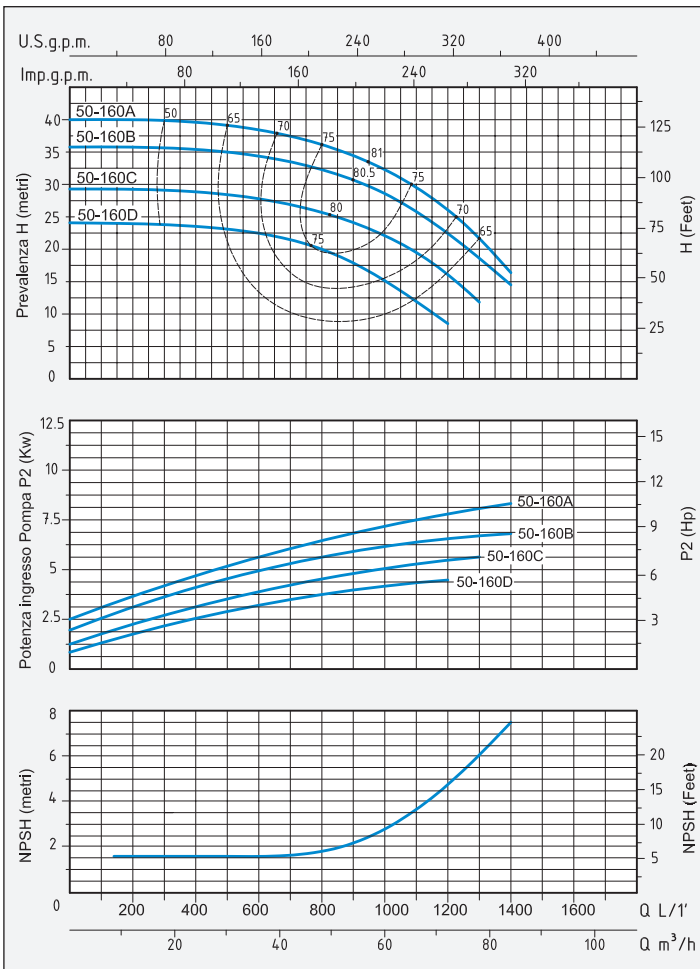
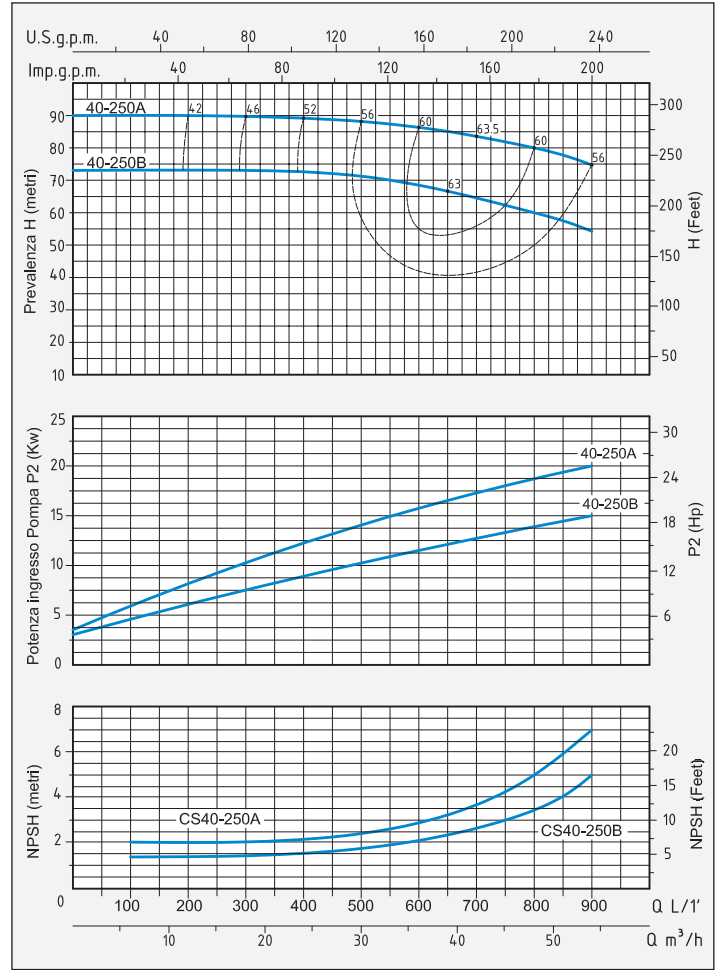
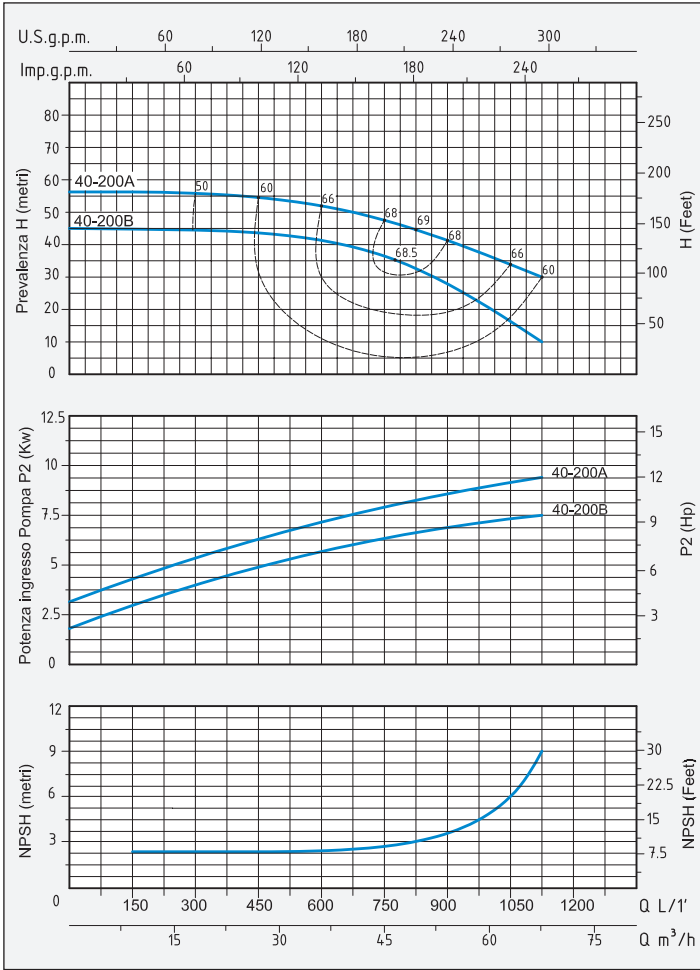

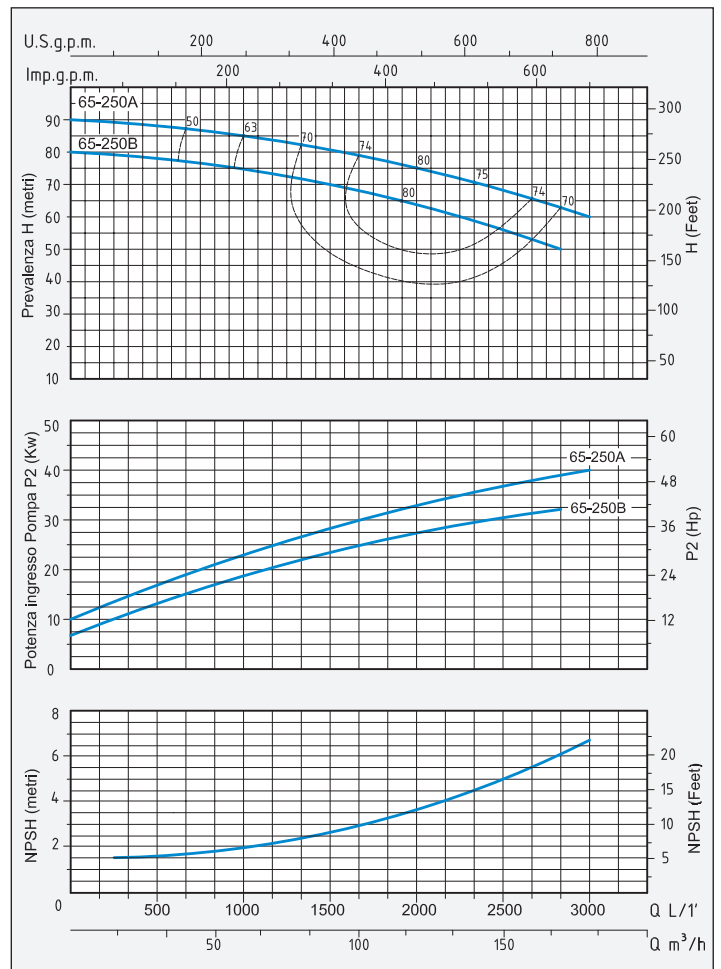
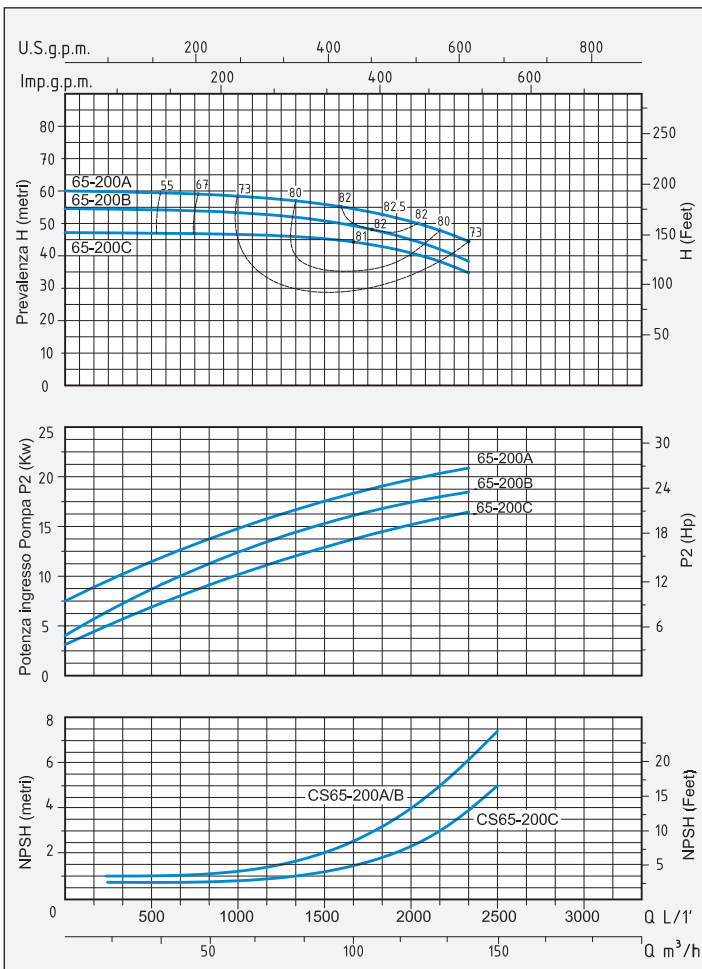
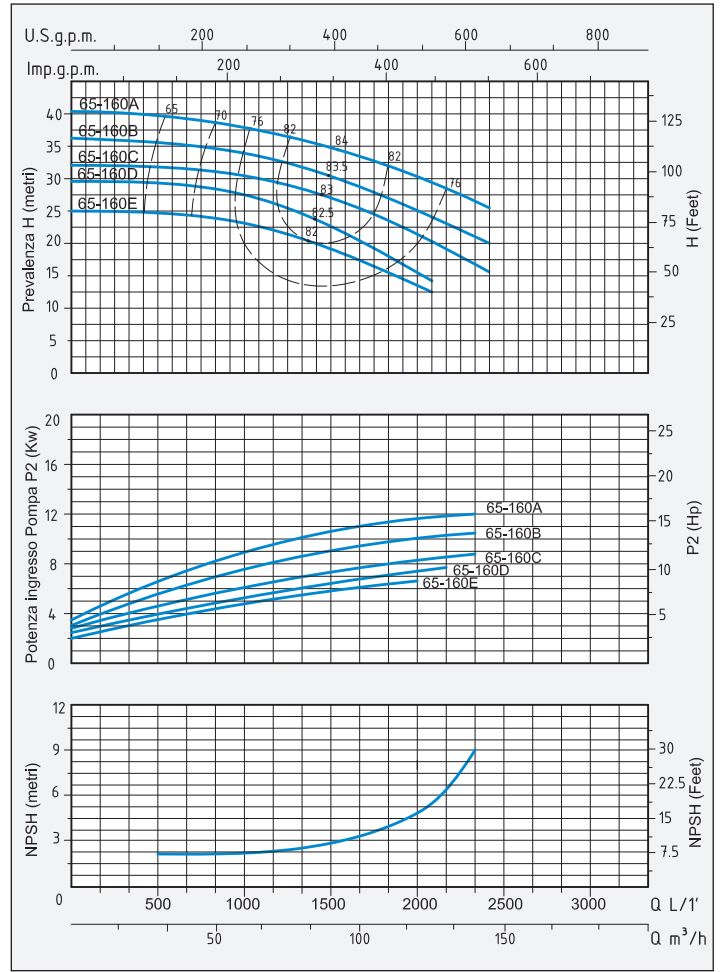
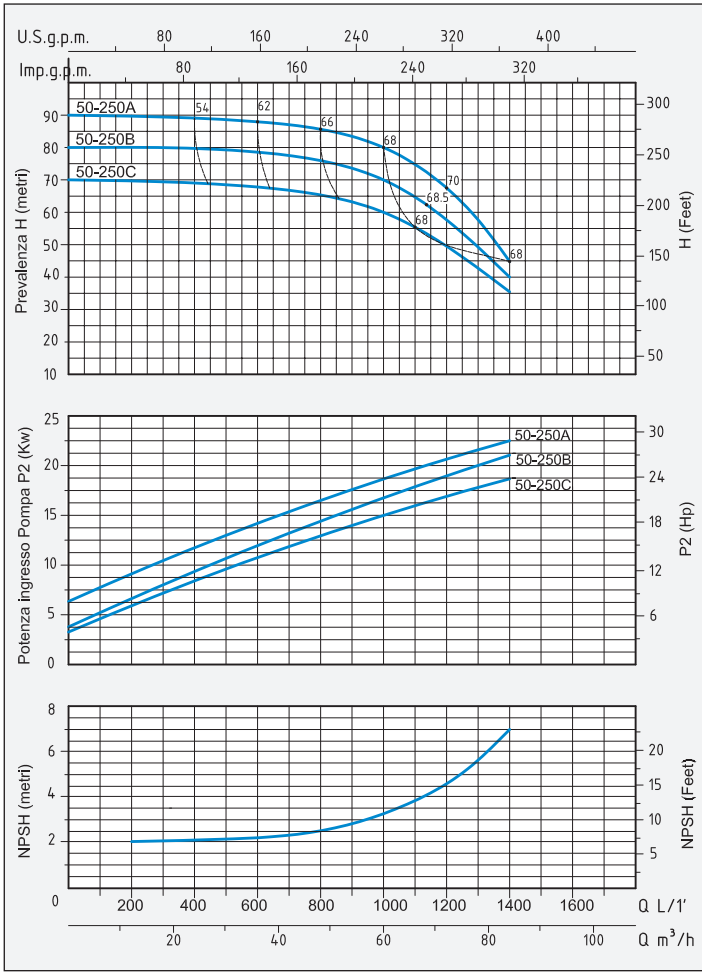

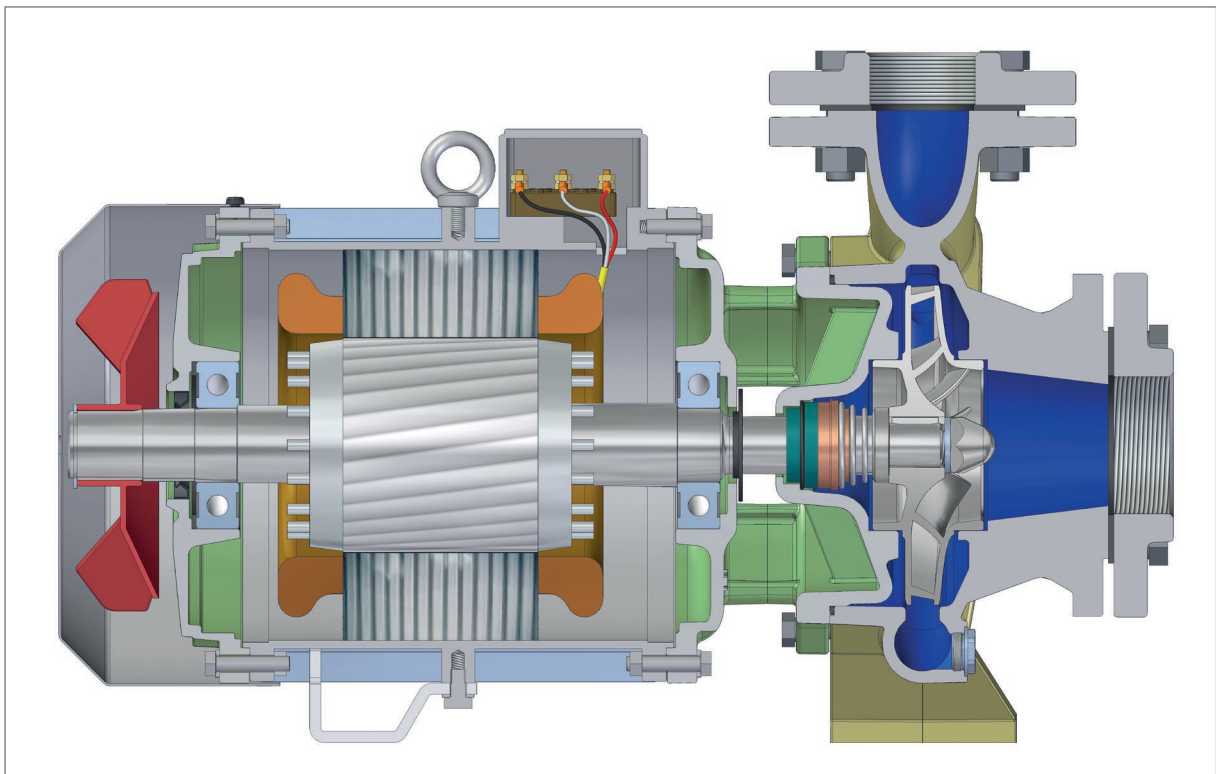
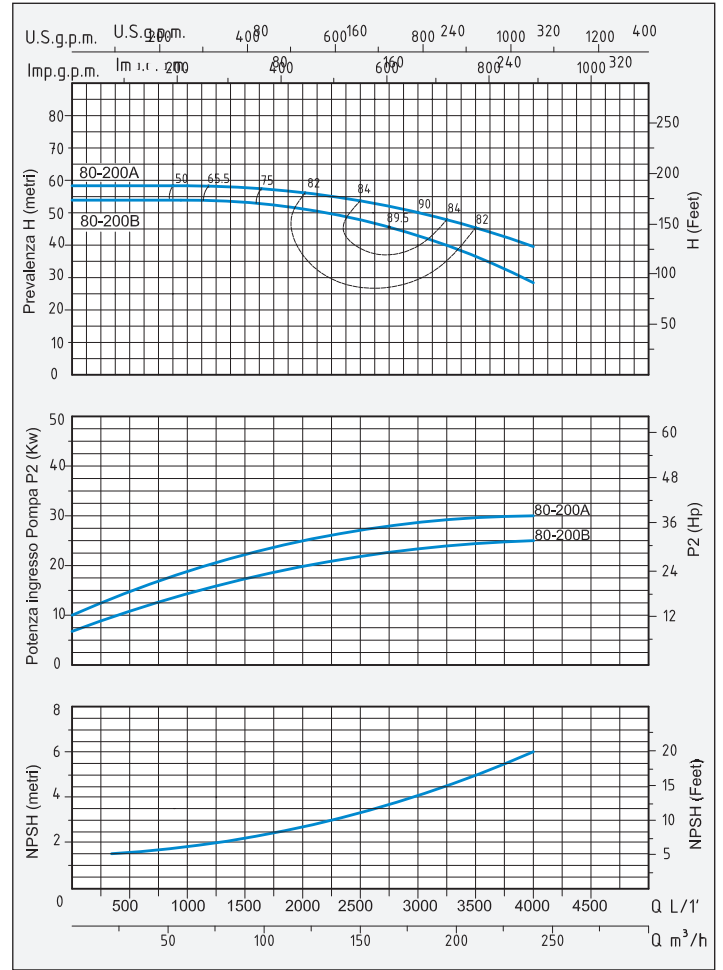
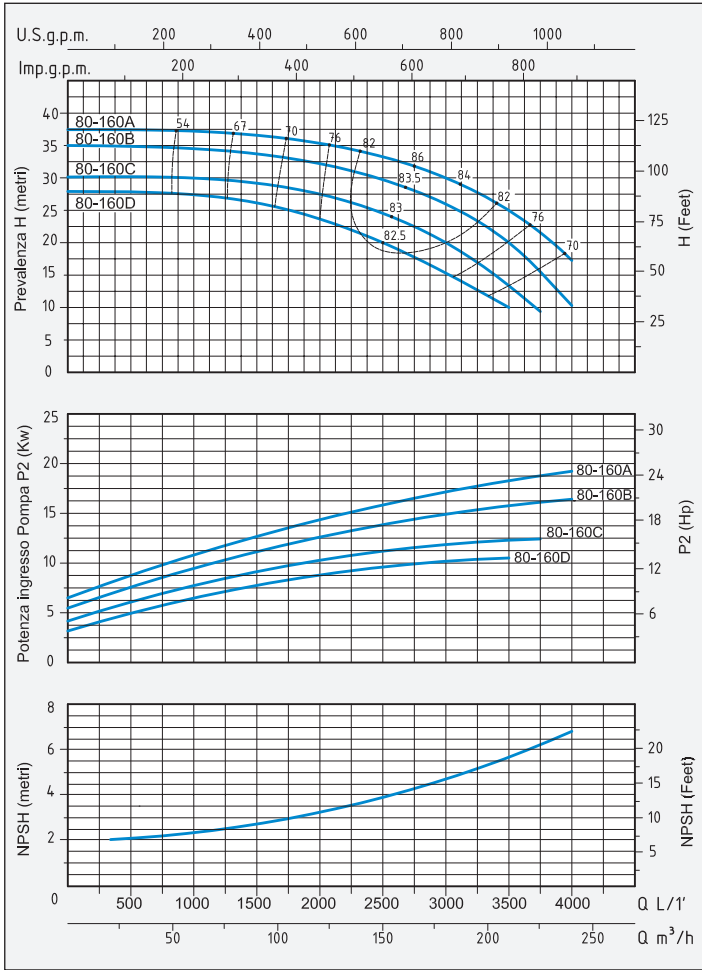

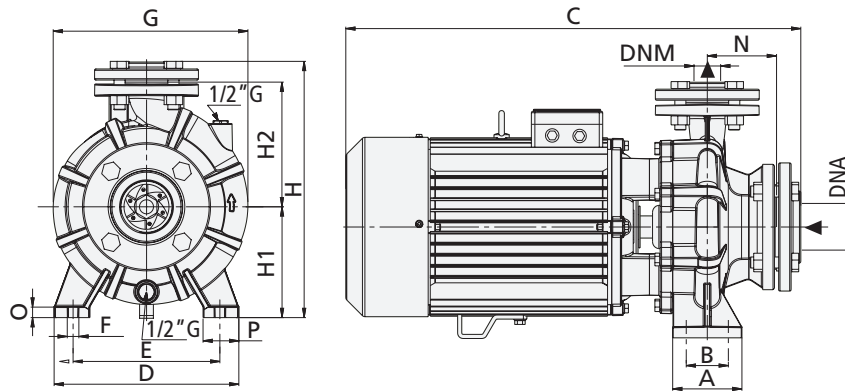
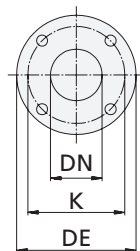

**Flange
Flanges**

DIMENSIONI mm - DIMENSIONS mm				
DN	DE	K	Fori - Holes	
			n°	Ø
32	140	100	4	18
40	150	110	4	18
50	165	125	4	18
65	185	145	4	18
80	200	160	8	18
100	220	180	8	18

TIPO TYPE		DIMENSIONI mm - DIMENSIONS mm															DIMENSIONI DIMENSIONS mm			PESO WEIGHT
Monofase Single-phase	Trifase Three-phase	A	B	C	D	E	F	G	H	H1	H2	N	O	P	DNA	DNM	P	L	H	Kg
M 32-160 C	32-160 C	100	70	480	240	190	15	240	322	132	160	80	13,5	50	50	32	270	540	430	39,4
M 32-160 B	32-160 B	100	70	480	240	190	15	240	322	132	160	80	13,5	50	50	32	270	540	430	43,5
	32-160 A	100	70	510	240	190	15	240	322	132	160	80	13,5	50	50	32	270	540	430	51
M 32-200 C	32-200 C	100	70	530	240	190	15	273	370	160	180	80	15	50	50	32	317	680	495	58,6
	32-200 B	100	70	630	240	190	15	273	370	160	180	80	15	50	50	32	317	680	495	72,3
	32-200 A	100	70	630	240	190	15	273	370	160	180	80	15	50	50	32	317	680	495	76,4
	32-250 C	125	95	745	320	250	15	335	445	180	225	100	18	65	50	32	372	805	550	129
	32-250 B	125	95	745	320	250	15	335	445	180	225	100	18	65	50	32	372	805	550	129,5
	32-250 A	125	95	745	320	250	15	335	445	180	225	100	18	65	50	32	372	805	550	139,5

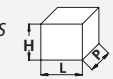
TIPO TYPE		DIMENSIONI mm - DIMENSIONS mm															DIMENSIONI DIMENSIONS mm			PESO WEIGHT
Monofase Single-phase	Trifase Three-phase	A	B	C	D	E	F	G	H	H1	H2	N	O	P	DNA	DNM	P	L	H	Kg
M 40-160 B	40-160 B	100	70	550	240	190	15	240	322	132	160	80	15	50	65	40	290	570	420	58,5
M 40-160 A	40-160 A	100	70	550	240	190	15	240	322	132	160	80	15	50	65	40	290	570	420	58,7
	40-200 B	100	70	640	265	212	15	281	370	160	180	100	15	50	65	40	317	680	495	75,8
	40-200 A	100	70	640	265	212	15	281	370	160	180	100	15	50	65	40	317	680	495	79,6
	40-250 B	125	95	745	320	250	15	335	435	180	225	100	18	65	65	40	372	805	550	130
	40-250 A	125	95	745	320	250	15	335	435	180	225	100	18	65	65	40	372	805	550	140

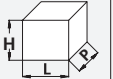
TIPO TYPE		DIMENSIONI mm - DIMENSIONS mm															DIMENSIONI DIMENSIONS mm 			PESO WEIGHT
Monofase Single-phase	Trifase Three-phase	A	B	C	D	E	F	G	H	H1	H2	N	O	P	DNA	DNM	P	L	H	Kg
M 50-160 D	50-160 D	100	70	570	265	212	15	268	372	160	180	100	15	50	65	50	317	680	495	61,1
M 50-160 C	50-160 C	100	70	570	265	212	15	268	372	160	180	100	15	50	65	50	317	680	495	61,5
	50-160 B	100	70	650	265	212	15	268	372	160	180	100	15	50	65	50	317	680	495	74,8
	50-160 A	100	70	650	265	212	15	268	372	160	180	100	15	50	65	50	317	680	495	79,1
	50-200 C	100	70	745	265	212	15	285	425	160	200	100	18	50	65	50	372	805	550	123
	50-200 B	100	70	745	265	212	15	285	425	160	200	100	18	50	65	50	372	805	550	123
	50-200 A	100	70	745	265	212	15	285	425	160	200	100	18	50	65	50	372	805	550	132
	50-250 C	125	95	750	320	250	15	340	435	180	225	100	18	65	65	50	395	865	561	142
	50-250 B	125	95	795	320	250	15	340	435	180	225	100	18	65	65	50	395	865	561	155
	50-250 A	125	95	825	320	250	15	360	455	180	225	100	18	65	65	50	395	865	561	210,5

TIPO TYPE		DIMENSIONI mm - DIMENSIONS mm															DIMENSIONI DIMENSIONS mm 			PESO WEIGHT
Trifase - Three-phase		A	B	C	D	E	F	G	H	H1	H2	N	O	P	DNA	DNM	P	L	H	Kg
	65-160 E	125	95	610	280	212	15	295	395	160	200	100	18	65	80	65	317	680	495	82,2
	65-160 D	125	95	610	280	212	15	295	395	160	200	100	18	65	80	65	317	680	495	85,6
	65-160 C	125	95	750	280	212	15	340	425	160	200	100	18	65	80	65	372	805	550	125
	65-160 B	125	95	750	280	212	15	340	425	160	200	100	18	65	80	65	372	805	550	125
	65-160 A	125	95	750	280	212	15	340	425	160	200	100	18	65	80	65	395	865	561	137
	65-200 C	125	95	745	320	250	15	335	445	180	225	100	18	65	80	65	395	865	561	141,5
	65-200 B	125	95	790	320	250	15	335	445	180	225	100	18	65	80	65	395	865	561	156
	65-200 A	125	95	825	320	250	15	360	455	180	225	100	18	65	80	65	395	865	561	215,5
	65-250 B	160	120	825	360	280	18	370	485	200	250	100	18	85	80	65	395	935	580	250
	65-250 A	160	120	825	360	280	18	370	485	200	250	100	18	85	80	65	395	935	580	258

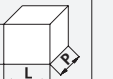
TIPO TYPE		DIMENSIONI mm - DIMENSIONS mm															DIMENSIONI DIMENSIONS mm 			PESO WEIGHT
Trifase Three-phase		A	B	C	D	E	F	G	H	H1	H2	N	O	P	DNA	DNM	P	L	H	Kg
	80-160 D	125	95	790	320	250	15	350	445	180	225	125	18	65	100	80	395	865	561	139
	80-160 C	125	95	790	320	250	15	350	445	180	225	125	18	65	100	80	395	865	561	148,5
	80-160 B	125	95	835	320	250	15	350	445	180	225	125	18	65	100	80	395	865	561	161
	80-160 A	125	95	870	320	250	15	360	445	180	225	125	18	65	100	80	395	935	580	219
	80-200 B	125	95	900	345	280	15	360	470	180	250	125	18	65	100	80	395	935	580	247
	80-200 A	125	95	900	345	280	15	360	470	180	250	125	18	65	100	80	395	935	580	258,5